



DATENBLATT

RPC-BD-10G-2733-10D

Produktspezifikationen

Stand: 06/2015



3KV GmbH
Landsberger Straße 110
80339 München
Tel.: +49 (0) 89 / 800 656 – 0
eMail: info@3kv.de
Web: www.3kv.de

RPC-BD-10G-2733-10D

10Gb/s BIDI SFP+ 10km Transceiver

PRODUCT FEATURES

- Up to 10.7Gbps Data Links
- Single Mode LC Receptacle
- Up to 20km transmission on SMF
- Power dissipation < 1.2W
- 1270nm DFB laser and PIN receiver
- 2-wire interface with integrated Digital Diagnostic monitoring
- EEPROM with Serial ID Functionality
- Compliant with SFP+ MSA with duplex LC connector
- Single + 3.3V Power Supply and LVTTTL Logic
- Case operating temperature: -5 °C ~ +70°C

APPLICATIONS

- 10GBASE-BX at 10.3125 Gb/s
- 10GBASE-BX at 9.953 Gb/s

STANDARD

- Compliant with SFF-8472 and SFP+ M.SA
- Compliant to SFP+ SFF-8431 and SFF-8432.
- Compliant to 802.3ae 10GBASE-LR.

PRODUCT DESCRIPTION

RPC-BD-10G-2733-10D is hot pluggable 3.3V Small-Form-Factor transceiver module. It designed expressly for high-speed communication applications that require rates up to 10.7Gbps, it designed to be compliant with SFF-8472 and SFP+ MSA. The module data link up to 10km in 9/125um single mode fiber. The optical output can be disabled by a LVTTTL logic high-level input of Tx Disable. Tx Fault is provided to indicate that degradation of the laser. Loss of signal (LOS) output is provided to indicate the loss of an input optical signal of receiver or the link status with partner.

I. Absolute Maximum Ratings

Parameter	Symbol	Min.	Typ.	Max.	Unit	Note
Storage Temperature	Ts	-40	-	85	°C	
Storage Ambient Humidity	HA	5	-	95	%	
Operating Relative Humidity	RH	-	-	85	%	
Power Supply Voltage	VCC	-0.3	-	4	V	
Signal Input Voltage		Vcc-0.3	-	Vcc+0.3	V	

II. Recommended Operating Conditions

Parameter	Symbol	Min.	Typ.	Max.	Unit	Note
Case Operating Temperature	Tcase	-5	-	70	°C	Without air flow
Power Supply Voltage	VCC	3.14	3.3	3.47	V	
Power Supply Current	ICC	-	270	350	mA	
Data Rate	BR		10.3125		Gbps	
Transmission Distance	TD		-	10	km	Note (1)
Coupled fiber		Single mode fiber				ITU-T SMF

Note : Measured with SMF

III. Optical Characteristics

Parameter	Symbol	Min.	Typ.	Max.	Unit	Note
Transmitter						
Average Launched Power	PO	-6	-	-1	dBm	
Average Launched Power(Laser Off)	Poff	-	-	-40	dBm	Note (1)
Optical Modulation Amplitude	OMA	-3	-	-	dBm	Note (1)
Center Wavelength Range	λ_C	1260	1270	1280	nm	
Side mode suppression ratio	SMSR	30	-	-	dB	
Spectrum Bandwidth(-20dB)	σ	-	-	1	nm	
Extinction Ratio	ER	3.5		-	dB	Note (2)
Output Eye Mask	Compliant with IEEE 0802.3ae					Note (2)
Receiver						
Input Optical Wavelength	λ_{IN}	1320	1330	1340	nm	
Receiver Sensitivity	Psen	-	-	-15	dBm	Note (3)
Input Saturation Power (Overload)	PSAT	0.5	-	-	dBm	Note (3)
LOS -Assert Power	PA	-30	-	-	dBm	
LOS -Deassert Power	PD	-	-	-17	dBm	
LOS -Hysteresis	PHys	0.5	-	5	dB	

Note:

1. The optical power is launched into SMF
2. Measured with RPBS 2^31-1 test pattern @10.3125Gbs
3. Measured with RPBS 2^31-1 test pattern @10.3125Gbs BER= $\leq 10^{-12}$

IV. Electrical Interface Characteristics

Parameter	Symbol	Min.	Typ.	Max.	Unit	Note
Total power supply current	I _{cc}	-	270-	350	mA	
Transmitter						
Differential Data Input Voltage	VDT	180	-	700	mVp-p	
Differential line input Impedance	RIN	85	100	115	Ohm	
Transmitter Fault Output-High	VFaultH	2.4	-	V _{cc}	V	
Transmitter Fault Output-Low	VFaultL	-0.3	-	0.8	V	
Transmitter Disable Voltage- High	VDisH	2	-	V _{cc} +0.3	V	
Transmitter Disable Voltage- low	VDisL	-0.3	-	0.8	V	
Receiver						
Differential Data Output Voltage	VDR	300	-	850	mVp-p	
Differential line Output Impedance	ROUT	80	100	120	Ohm	
Receiver LOS Pull up Resistor	RLOS	4.7	-	10	KOhm	
Data Output Rise/Fall time	tr/tf		-	38	ps	
LOS Output Voltage-High	VLOSH	2	-	V _{cc}	V	
LOS Output Voltage-Low	VLOSL	-0.3	-	0.4	V	

Pin Description

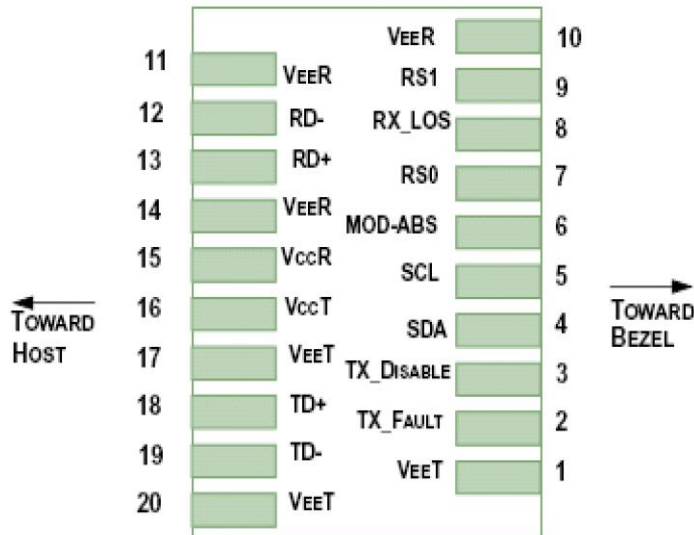

Diagram of Host Board Connector Block Pin Numbers and Name

Pin	Symbol	Name/Description	Ref.
1	V_{EET}	Transmitter Ground (Common with Receiver Ground)	1
2	T_{FAULT}	Transmitter Fault.	2
3	T_{DIS}	Transmitter Disable. Laser output disabled on high or open.	3
4	SDA	2-wire Serial Interface Data Line	4
5	SCL	2-wire Serial Interface Clock Line	4
6	MOD_ABS	Module Absent. Grounded within the module	4
7	RS0	Rate Select 0	5
8	LOS	Loss of Signal indication. Logic 0 indicates normal operation.	6
9	RS1	No connection required	1
10	V_{EER}	Receiver Ground (Common with Transmitter Ground)	1
11	V_{EER}	Receiver Ground (Common with Transmitter Ground)	1
12	RD-	Receiver Inverted DATA out. AC Coupled	
13	RD+	Receiver Non-inverted DATA out. AC Coupled	
14	V_{EER}	Receiver Ground (Common with Transmitter Ground)	1
15	V_{CCR}	Receiver Power Supply	
16	V_{CCT}	Transmitter Power Supply	
17	V_{EET}	Transmitter Ground (Common with Receiver Ground)	1
18	TD+	Transmitter Non-Inverted DATA in. AC Coupled.	
19	TD-	Transmitter Inverted DATA in. AC Coupled.	
20	V_{EET}	Transmitter Ground (Common with Receiver Ground)	1

Notes:

1. Circuit ground is internally isolated from chassis ground.
2. T_{FAULT} is an open collector/drain output, which should be pulled up with a 4.7k – 10k Ohms resistor on the host board if intended for use. Pull up voltage should be between 2.0V to $V_{\text{cc}} + 0.3\text{V}$. A high output indicates a transmitter fault caused by either the TX bias current or the TX output power exceeding the preset alarm thresholds. A low output indicates normal operation. In the low state, the output is pulled to $<0.8\text{V}$.
3. Laser output disabled on $T_{\text{DIS}} > 2.0\text{V}$ or open, enabled on $T_{\text{DIS}} < 0.8\text{V}$.
4. Should be pulled up with 4.7k Ω - 10k Ω host board to a voltage between 2.0V and 3.6V. MOD_ABS pulls line low to indicate module is plugged in.
5. Internally pulled down per SFF-8431 Rev 4.1.
6. LOS is open collector output. It should be pulled up with 4.7k Ω – 10k Ω on host board to a voltage between 2.0V and 3.6V. Logic 0 indicates normal operation; logic 1 indicates loss of signal.

VI. Recommended Interface Circuit

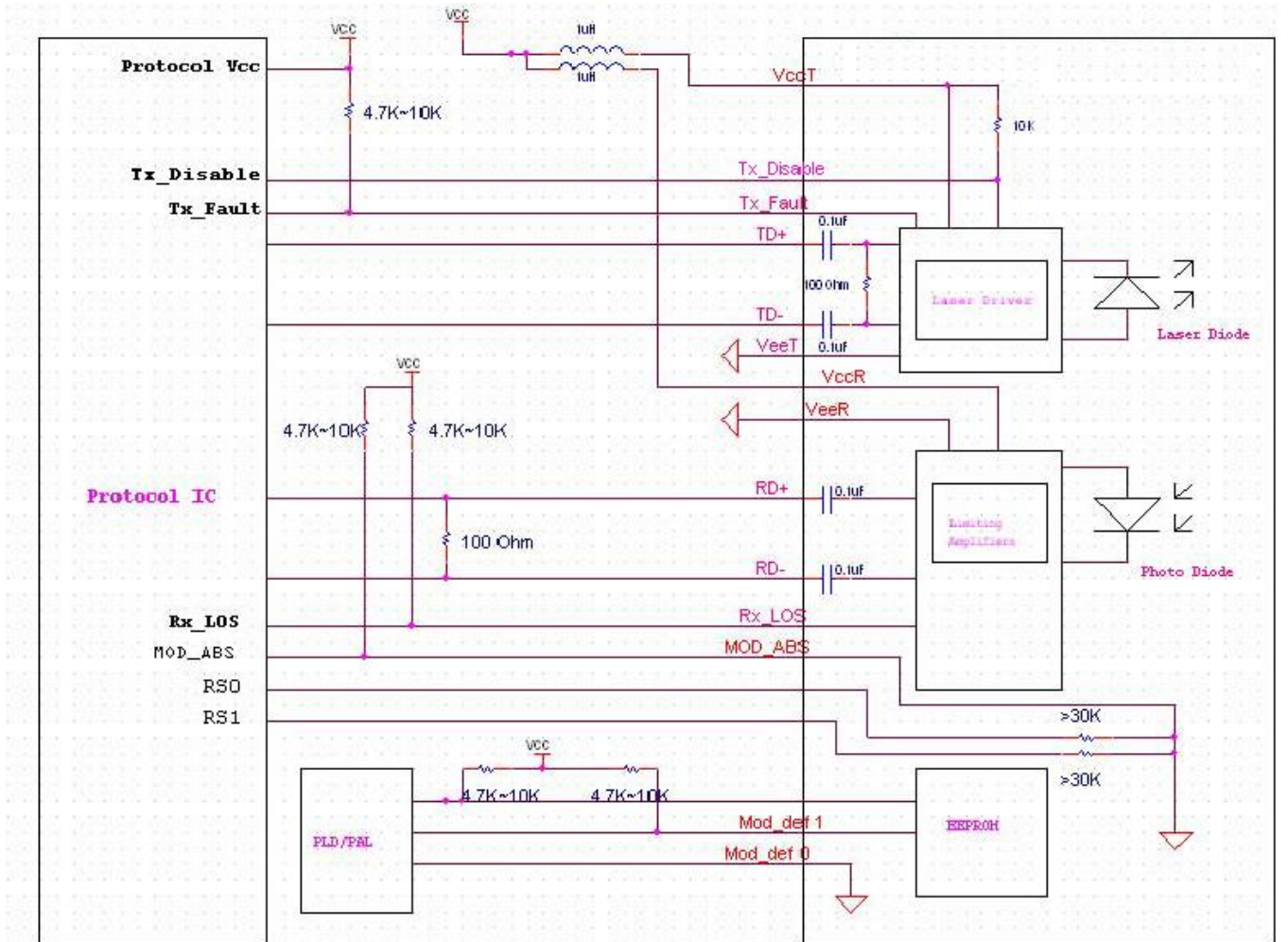

VII. Outline Dimensions

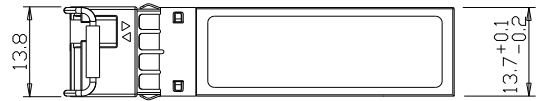

Units in mm

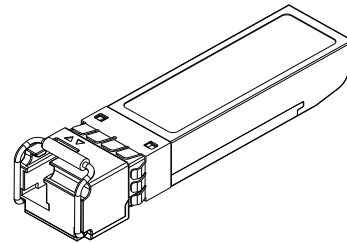
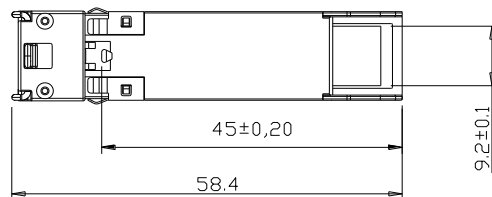
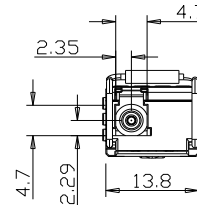
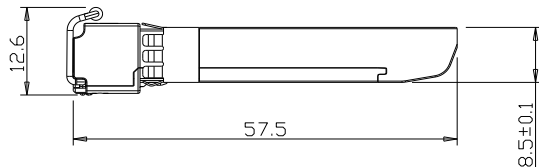

VIII. Regulatory Compliance

Feature	Reference	Performance
Electrostatic discharge (ESD)	IEC/EN 61000-4-2	Compatible with standards
Electromagnetic Interference (EMI)	FCC Part 15 Class B EN 55022 Class B (CISPR 22A)	Compatible with standards
Laser Eye Safety	FDA 21CFR 1040.10, 1040.11 IEC/EN 60825-1, 2	Class 1 laser product
Component Recognition	IEC/EN 60950 , UL	Compatible with standards
ROHS	2002/95/EC	Compatible with standards
EMC	EN61000-3	Compatible with standards